

ACCESSORIES COUPLING AND FITTINGS

Union re-usable coupling



PRODUCTS' RANGE

Code	Description	Inlet/Outlet			Key 1	Key 2
		A BSP	B mm	C mm		
Swivel						
000890000	Union 34.27	3/4"	19	27	38	38
000891000	Union 1.27	1"	19	27	31	31
000892000	Union 1.35	1"	25	35	38	38
000893000	Union 34.32	3/4"	19	32	31	31
000894000	Union 1.32	1"	19	32	38	38
000895000	Union 1.38	1"	25	38	38	38

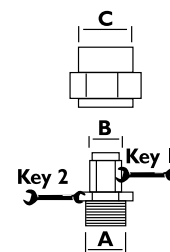

1



2



3



4

HQC Hose Quick Coupling

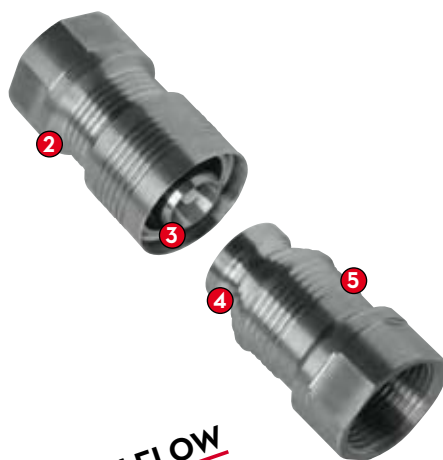

HIGH FLOW

IT. Raccordo rapido per tubo PIUSI ha sviluppato un nuovo raccordo rapido adatto all'utilizzo con gasolio. In passato i raccordi rapidi per gasolio derivavano da raccordi rapidi per olio, e i fori interni non erano sufficientemente grandi per la portata della erogazione del gasolio. Oggi il foro di questo raccordo rapido è stato progettato per ridurre al minimo la resistenza in presenza di alte portate durante l'erogazione del gasolio.

1 - Posizione tutto chiuso
2 - Posizione aperto
3 - Attacco maschio
4 - Attacco femmina
5 - Profilo in rilievo: migliora la presa in fase di aggancio-sgancio.

FR. Raccord rapide pour tuyau, PIUSI a développé un nouveau raccordo rapide approprié au gasoil. Auparavant, les raccords rapides pour gasoil dérivait de raccords rapides pour huile et les orifices internes n'étaient pas suffisamment grands pour le débit du gasoil. Par contre, l'orifice de ce raccordo rapide a été conçu pour réduire au minimum la résistance en présence de hauts débits lors de la distribution du gasoil.

1 - Position tout fermé
2 - Position tout ouvert
3 - Raccord mâle
4 - Raccord femelle
5 - Profil en relief: améliore la préhension lors de l'enclenchement - déclenchement.

DE. Schlauch-Schnellkupplung PIUSI hat eine, zur Verwendung mit Diesel geeignete neue Schlauch-Schnellkupplung entwickelt. Einstige Schnellkupplungen für Diesel waren von Schnellkupplungen für Öl abgeleitet und deren innere Durchmesser waren nicht groß genug für den Durchfluss der Dieselabgabe. Nun wurde der Durchmesser dieser Schnellkupplung so entworfen, dass der Widerstand bei hohen Durchflüssen während der Abgabe von Diesel auf ein Minimum verringert ist. 1 - Position ganz geschlossen
2 - Position geöffnet
3 - Anschluss mit Außengewinde
4 - Anschluss mit Innengewinde
5 - Erhabenes Profil: Für besseren Griff beim Zusammenstecken-Herausziehen.

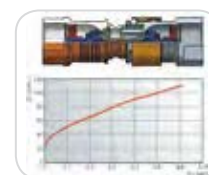

IT. Profilo interno sagomato: riduce le perdite di carico.

FR. Profil interne façonné: réduit les pertes de charge.

DE. Inneres Formprofil: Reduziert den Strömungsverlust.

PRODUCTS' RANGE

Code	Description	Weight	Pack.	Packaging
		Kg	pcs. no.	mm
HQC				
F00636000	HQC Hose Quick Coupling 1"	0,46	1	80x80x75

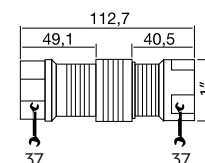



PRODUCTS' RANGE

Elbows



Code	Description	A	B	Q.ty	Key
Elbows					
F07806000		F 3/4" BSP	F 3/4" BSP	-	-
F07805000		M 3/4" BSP	F 3/4" BSP	-	-
F08609000		F 1" BSP	F 1" BSP	-	-
F07988000		M 1" BSP	F 1" BSP	-	-
F14279000	Inox	M 1" BSP	F 1" BSP	-	-

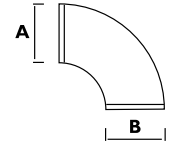

Hose tails



Inox Version

Hose tails					
F0826700A		1/2" BSP	19 mm	1	24
F0643700A		3/4" BSP	19 mm	20	32
F0776800B		3/4" BSP	25 mm	20	32
F0775700A		1" BSP	19 mm	20	37
F0776400A		1" BSP	25 mm	20	37
F14122000	Inox	M 1" BSP	19 mm	1	37
F14123000	Inox	F 3/4" BSP	19 mm	1	37

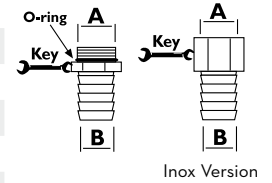

Rotating hose tails - Inox



Rotating hose tail - Inox					
F14132000	Inox	3/4" BSP	19 mm	-	27

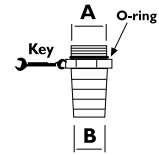

Sleeve



Sleeve					
F08137000		28 mm	20 mm	-	30
F08138000		36 mm	28 mm	-	35

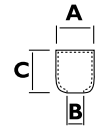

Sleeve



Sleeve					
F07766000		M 3/4" BSP	M 3/4" BSP	-	27
F07765000		M 1" BSP	M 1" BSP	-	34

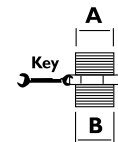

Reducing sockets



Reducing sockets					
F07441000		F 1/2" BSP	M 3/4" BSP	-	30
F07762000		M 3/4" BSP	M 1" BSP	-	34
F08913000		M 1" BSP	M 1 1/2" BSP	-	50
F07760000		F 3/4" BSP	M 1" BSP	-	35
F07889000		F 1" BSP	M 3/4" BSP	-	34
008891000		F 1" BSP	M 2" BSP	-	60

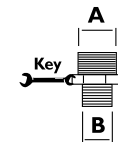

Elbow rotating connector



M/1" BSP

Code **F14567000**

Sealant paste

Code	Description		Q.ty
F08173000	Light removable	g. 130	1
F10767000	Medium removable	ml. 250	1
F12278000	Heavy non removable	ml. 250	1



DISPENSERS

PUMPS

METERS

NOZZLE METERS

NOZZLE

SPECIAL EQUIPMENTS

FLUID MONITORING

HOSE REEL

ACCESSORIES